

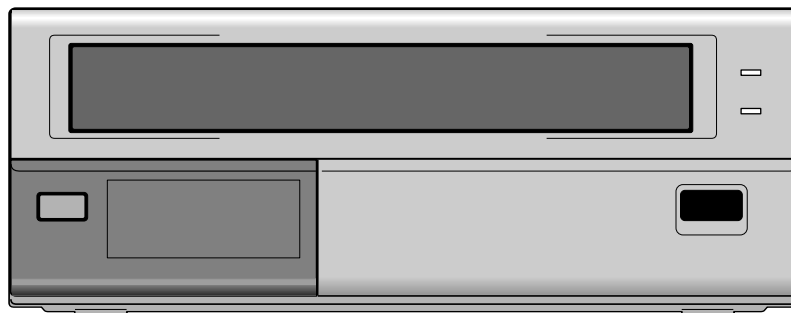

## INSTRUCTION MANUAL

## SRC-800

### Video Cassette Recorder



Please read this manual and accompanying "IMPORTANT SAFETY INSTRUCTIONS" sheet carefully before connecting your VCR and operating it for the first time.  
Be sure to read carefully and follow all the PRECAUTIONS on page 2.  
Keep the manual in a safe place for future reference.

# PRECAUTIONS



## CAUTION

RISK OF ELECTRIC SHOCK  
DO NOT OPEN



**CAUTION:** TO REDUCE THE RISK OF ELECTRIC SHOCK, DO NOT REMOVE COVER. NO USER-SERVICEABLE PARTS INSIDE. REFER SERVICING TO QUALIFIED SERVICE PERSONNEL.

**WARNING:** To reduce the risk of fire or electric shock, do not expose this appliance to rain or other moisture.

**CAUTION:** Changes or modifications not expressly approved by the manufacturer may void the user's authority to operate this equipment.

## Location

For safe operation and satisfactory performance of your VCR, keep the following in mind when selecting a place for its installation:

- Shield it from direct sunlight and keep it away from sources of intense heat.
- Avoid dusty or humid places.
- Avoid places with insufficient ventilation for proper heat dissipation. Do not block the ventilation holes of the VCR. Do not place the unit on a carpet because this will block the ventilation holes.
- Install the VCR in a horizontal position only.
- Avoid locations subject to strong vibrations.
- Avoid moving the VCR between cold and hot locations (see "Moisture Condensation Problems", this page).
- Do not place the VCR directly on top of the TV, as this may cause playback or recording problems.

## Avoiding Electrical Shock and Fire

- Do not handle the power cord with wet hands.
- Do not pull on the power cord when disconnecting it from an AC wall outlet. Grasp it by the plug.
- If any liquid is spilled on the VCR, unplug the power cord immediately and have the unit inspected at a factory-authorized service center.
- Do not place anything directly on top of this VCR.



THIS SYMBOL INDICATES THAT DANGEROUS VOLTAGE CONSTITUTING A RISK OF ELECTRIC SHOCK IS PRESENT WITHIN THIS UNIT.



THIS SYMBOL INDICATES THAT THERE ARE IMPORTANT OPERATING AND MAINTENANCE INSTRUCTIONS IN THE LITERATURE ACCOMPANYING THIS UNIT.

This equipment has been tested and found to comply with the limits for a Class B digital device, pursuant to Part 15 of the FCC Rules. These limits are designed to provide reasonable protection against harmful interference when the equipment is operated in a commercial environment. This equipment generates, uses, and can radiate radio frequency energy and, if not installed and used in accordance with the instruction manual, may cause harmful interference to radio communications. Operation of this equipment in a residential area is likely to cause harmful interference in which case the user will be required to correct the interference at his own expense.

## Moisture Condensation Problems

### Cause:

When the VCR is first installed, moved from a cold area to a warm area or placed in a location with high humidity, dew (moisture) may form in the unit. The Dew indicator (ddd) blinks. If you operate the VCR with dew inside, damage may result.

### Prevention:

- ① Make all necessary connections.
- ② Plug the power cord into a 120V AC wall outlet.
- ③ Do not operate the VCR for approximately 2 hours.

When the VCR reaches room temperature, the Dew indicator (ddd) will turn off and the VCR will be ready to operation.

## For the customers in Canada

"This digital apparatus does not exceed the Class B limits for radio noise emissions from digital apparatus as set out in the interference-causing equipment standard entitled "Digital Apparatus", ICES-003 of the Department of Communications."

# FEATURES

- High-speed Fast Forward/Rewind
- 8-hour mode recording audio playback
- On-screen mode setting
- Integrated time date generator
- Day/Time search function
- Forward field advance function
- 30-day memory backup
- Security lock
- Head-cleaning function

# ACCESSORY

Power cord

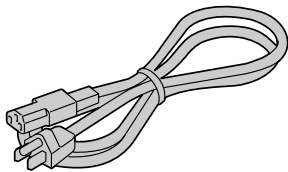

# CONTENTS

PRECAUTIONS .....	2
FEATURES .....	3
ACCESSORY .....	3
LOCATIONS OF CONTROLS AND INDICATORS .....	4
CONNECTIONS .....	7
TYPES OF ON-SCREEN DISPLAYS AND DISPLAY SEQUENCE .....	8
SETTING THE LANGUAGE AND CLOCK .....	9
CHANGING THE ON-SCREEN DISPLAY .....	10
VIDEO CASSETTE TAPES .....	11
NORMAL RECORDING .....	12
SERIES RECORDING .....	14
PLAYBACK .....	16
DAY/TIME SEARCH .....	17
SETTING THE SECURITY LOCK .....	18
CLOCK ADJUSTMENT .....	18
SETTING THE CASSETTE EJECT MODE .....	19
CHECKING USAGE DURATION, POWER FAILURE AND FAILURE DUE TO CONDENSATION .....	20
MAINTENANCE .....	21
TROUBLESHOOTING GUIDE .....	22
SPECIFICATIONS .....	23
WARRANTY .....	24

# LOCATIONS OF CONTROLS AND INDICATORS

## Front Panel

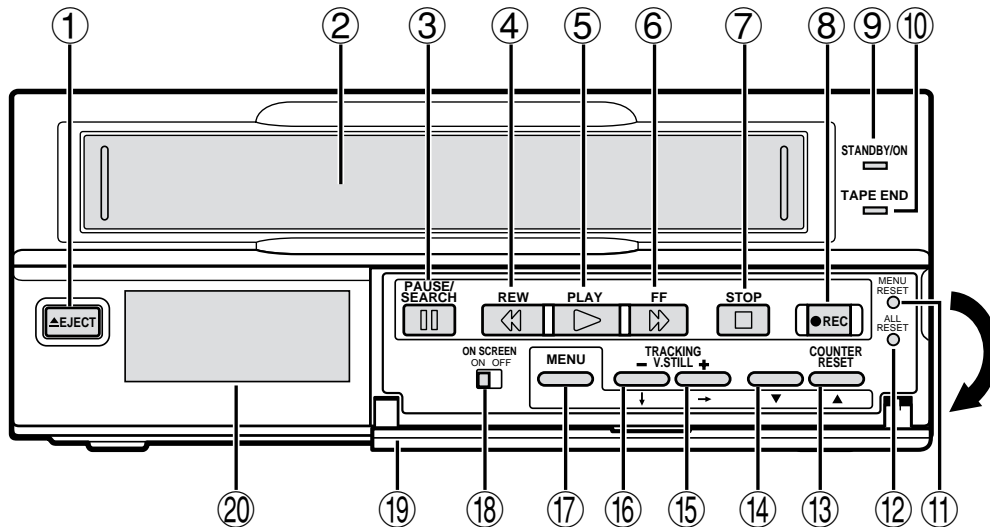

- ① **EJECT** button
- ② Cassette loading slot
- ③ **PAUSE/SEARCH** button
- ④ **REW** (rewind/review) button
- ⑤ **PLAY** button
- ⑥ **FF** (fast forward/cue) button
- ⑦ **STOP** button
- ⑧ **REC** (record) button
- ⑨ **STANDBY/ON** indicator
- ⑩ **TAPE END** indicator
- ⑪ **MENU RESET** button
- ⑫ **ALL RESET** button
- ⑬ **COUNTER RESET, ▲** button  
When the counter is displayed on the digital display panel, press this button to reset it to 0:00:00.
- ⑭ **▼** button
- ⑮ **TRACKING/V. STILL +, →** button
- ⑯ **TRACKING/V. STILL -, ↓** button
- ⑰ **MENU** button  
Press this button to display the menu.  
Buttons ⑬, ⑭, ⑮ and ⑯ are used for menu control.
- ⑱ **ON SCREEN** switch
- ⑲ Front door
- ⑳ Digital display panel

# LOCATIONS OF CONTROLS AND INDICATORS

## Digital Display

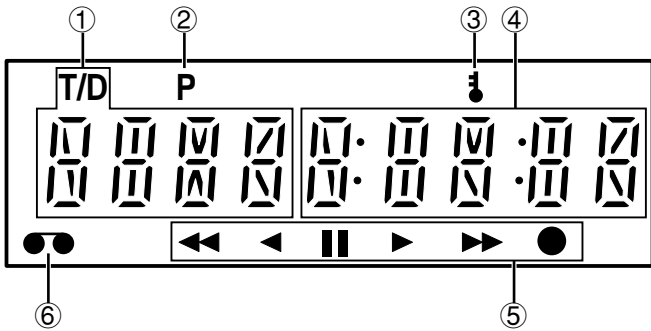

- ① Mode display
- Recording/playback speed mode
  - Day/Time search mode



- ② Power failure indicator **P**
- Comes on after a power failure.

- ③ Security lock indicator 
- Comes on when the security lock is engaged.

- ④ Counter display
- Time display
  - Linear time counter display

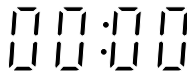



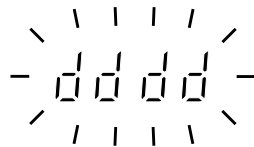









- Dew display



## ⑤ Operation Indicators

- They display the actual operation mode.

Operation Mode	Indicator
Record (REC)	●
Record pause (REC PAUSE)	● + 
Playback (PLAY)	
Still image (STILL)	 + 
Fast forward (FF)	
Rewind (REW)	
Cue (CUE)	 + 
Review (REVIEW)	 + 
Field shift forward (FIELD SHIFT +)	 + 

- ⑥ Cassette indicator 
- Comes on when a cassette is loaded.

# LOCATIONS OF CONTROLS AND INDICATORS

## Back Panel

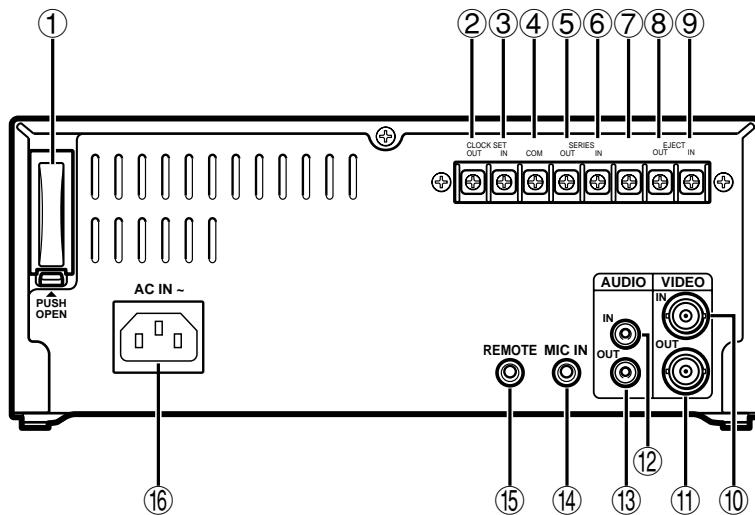

- ① Battery compartment cover
  - ② CLOCK SET OUT (external clock set trigger output) terminal
  - ③ CLOCK SET IN (external clock set trigger input) terminal
  - ④ COM (common) terminal
    - Common GND (ground) terminal when connecting other terminals to external devices.
  - ⑤ SERIES OUT (series recording trigger output) terminal
  - ⑥ SERIES IN (series recording trigger input) terminal
  - ⑦ Do not use
  - ⑧ EJECT OUT (eject trigger output) terminal
  - ⑨ EJECT IN (eject trigger input) terminal
  - ⑩ VIDEO IN (video input) jack
  - ⑪ VIDEO OUT (video output) jack
  - ⑫ AUDIO IN (audio input) jack
  - ⑬ AUDIO OUT (audio output) jack
  - ⑭ MIC IN (microphone input) jack
  - ⑮ REMOTE (remote control input) jack
    - You can use a VA-RMN01 Remote Control Unit (sold separately) to control remotely the VCR.
- NOTES:**
- The functions not available on the VCR will not operate.
  - The **MENU** button on the VA-RMN01 will function as the **EJECT** button on the VCR.
- ⑯ AC Power input

# CONNECTIONS

Connect the video camera and monitor TV as shown in the figure below.

**NOTE:** Before making the connections, make sure all the devices are disconnected from the power outlet.

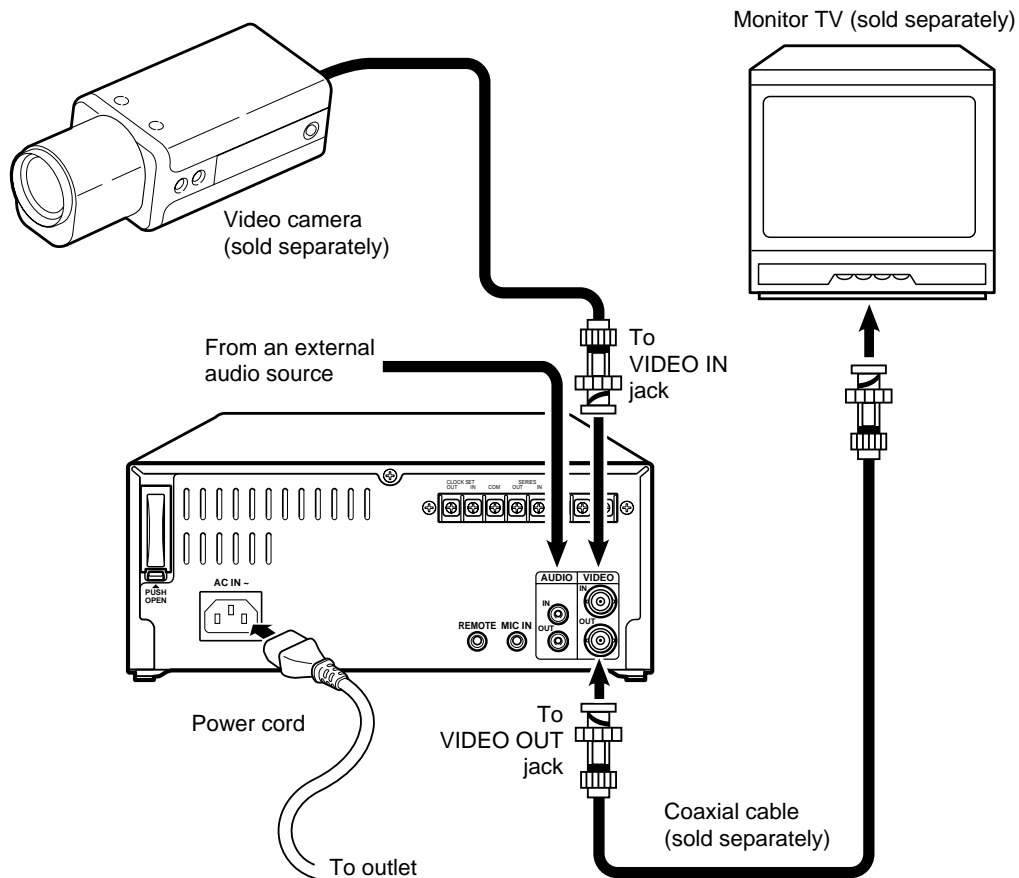

## Power Cord Installation

- 1 Plug the supplied power cord firmly into the AC power input **AC IN** socket.
- 2 Insert the plug of this power cord into a outlet.

## About the memory reset

If the VCR location is changed or to cancel previous settings, please reset the memory as described below.

The time and date will be reset.

To reset the memory, press the **ALL RESET** button.

## NOTE:

- For more details, please refer to the manuals accompanying all other devices. If the connections are not made properly, it may cause a fire or damage the equipment.

# TYPES OF ON-SCREEN DISPLAYS AND DISPLAY SEQUENCE

## NOTES:

- When a menu is displayed, recording will not be possible.
- Press the **PAUSE/SEARCH** or **MENU** button, the setting procedure is now completed.
- During recording or playback the menus cannot be displayed.
- To reset the settings of a menu to their original values, select the desired menu then press the **MENU RESET** button. The (USED TIME) menu data cannot be reset.
- To enter the settings use the ↓, →, ▼ or ▲ buttons.

Monitor TV screen (normal screen)

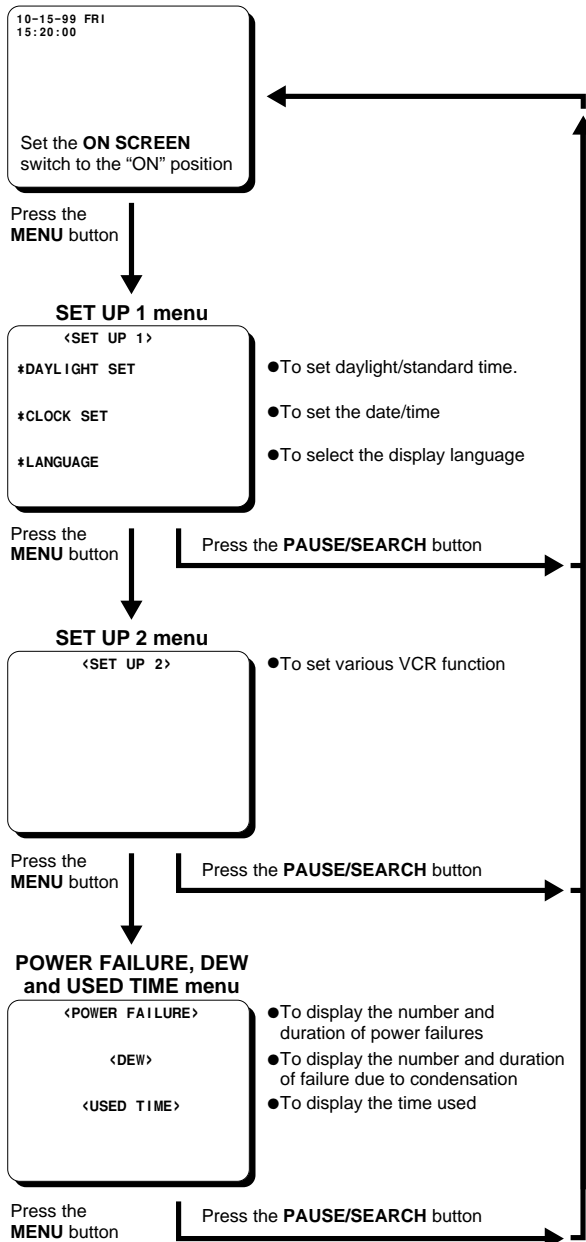

## Buttons functions

- Button ↓: To move down
- Button →: To move to the right
- Button ▼: To select numbers or switch settings in reverse order
- Button ▲: To select numbers or switch settings in order



# SETTING THE LANGUAGE AND CLOCK

## Language Setting

English or French can be selected by the user.

- ❶ Turn the power on to all devices used.
- ❷ Press the **MENU** button to display the (SET UP 1) menu.

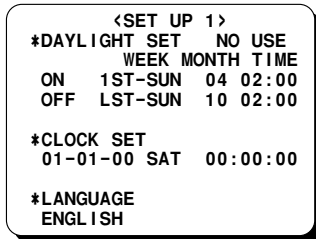

- ❸ Press the ↓ button, until “ENGLISH” is flashing.
- ❹ Press the ▼ (or ▲) button to select the language of your choice.
- ❺ When finished, press the **PAUSE/SEARCH** button to save the settings.

## Clock Setting

**Example:** To set the clock to October 15, 1999 at 3:20 PM (15:20).

- ❶ Press the **MENU** button to display the (SET UP 1) menu.
- ❷ Press the ▼ (or ▲) button, to set the auto daylight/standard time adjustment.
  - NO USE . . . . . No daylight/standard time adjustment made.
  - USE . . . . . The auto daylight/standard time adjustment made.

- ❸ Press the ↓ button.
- ❹ Set the day the daylight saving time adjustment is made.
  - Press the ▼ (or ▲) button to set the week, then press the → button.  
1ST, 2ND, 3RD, 4TH or LST (first, second, third, fourth or last)
  - Press the ▼ (or ▲) button to set the day of the week, then press the → button.  
SUN, MON, TUE, ..... SAT (Sunday, Monday, Tuesday....Saturday)
- ❺ Press the ▼ (or ▲) button to set the month the daylight saving time adjustment is made, then press the → button.  
01, 02,.....11, 12 (for January, February.....November, December)

- ❻ Press the ▼ (or ▲) button to set the time the daylight saving time adjustment is made.
- ❼ Press the ↓ button.
- ❽ Following the same procedure as above (steps ❹ to ❻), set when the time is changed back from daylight saving time to standard time.
- ❾ Press the ↓ button.
- ❿ Press the ▼ (or ▲) button to set the month (ex: 10), then press the → button.
  - *The day of week is set automatically.*
- ⓫ Press the ▼ (or ▲) button to set the day (ex: 15), then press the → button.
- ⓬ Press the ▼ (or ▲) button to set the year (ex: 99 for 1999), then press the → button.

### NOTE:

- The last 2 digits only are displayed.

- ⓭ Press the ▼ (or ▲) button to set the hours (ex: 15 for 3 PM), then press the → button.
- ⓮ Press the ▼ (or ▲) button to set the minutes (ex: 20), then press the → button.
- ⓯ For accurate clock setting, press the ▼ button timed with a time broadcast, or other accurate time signal, this will start the seconds counting from 00.

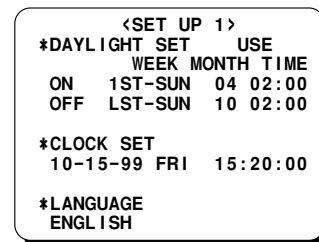

- ⓰ When finished, press the **PAUSE/SEARCH** button to save the settings.

# CHANGING THE ON-SCREEN DISPLAY

## Selecting the On-screen Display

You can select to display or not the date and time.

- 1 Turn the power on to all devices used.
- 2 Press the **MENU** button until the (SET UP 2) menu is displayed.

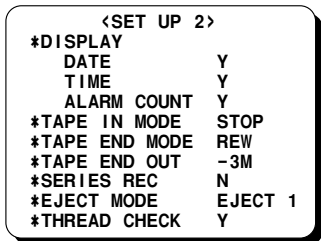

- 3 Press the ↓ button, until the desired item for which the display function will be set is flashing.
- 4 Press the ▼ (or ▲) button to set “Y” for the functions described below.  
DATE . . . . . The date is displayed  
TIME . . . . . The time is displayed
- 5 Press the **PAUSE/SEARCH** button, the normal screen is displayed.

◦ *The setting procedure is now completed.*

### NOTE:

- If the **ON SCREEN** switch is set to the “ON” position, the items for which “Y” is set are recorded. The items for which “N” was set at step 4 above are not recorded.

## Changing the Date/Time Display Position

- 1 Turn the power on to all devices used.
- 2 Set the **ON SCREEN** switch to the “ON” position.
  - *The date and time are displayed.*

Date/Time display

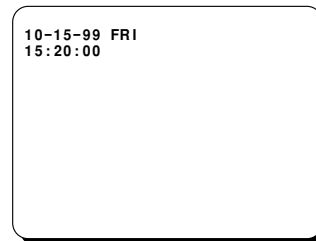

- 3 Press the → (or ↓) button.
  - *The display will move towards the right (or the bottom).*

### NOTES:

- If the → (or ↓) button is kept pressed for 1 second or more the display will move at a faster speed.
- The display position cannot be changed while recording.

# VIDEO CASSETTE TAPES

Use only video cassette tapes bearing the **VHS** logo. This VCR was primarily designed for use with T-160 cassette tapes, it is recommended to use T-160 VHS video cassette tapes for optimal performance.

## Handling Cassette Tapes

The cassette tapes should always be stored vertically, in their cases, away from high temperatures, magnetic fields, direct sunlight, dirt, dust and locations subject to mold formation.

Do not tamper with the cassette mechanism and never touch the tape with your fingers.

Protect the cassette tapes from shocks or strong vibrations.

## To Protect your Recordings

After having recorded a tape, if you wish to keep the recording, use a flathead screwdriver to break off the erasure-prevention tab on the cassette.

To record again on a tape without erasure-prevention tab, cover the hole with adhesive tape.

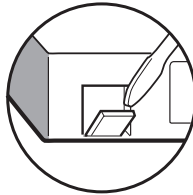
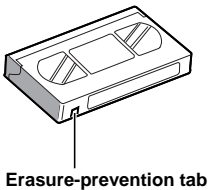

## Loading

- 1 Place the cassette, label side up, in the loading slot. Gently push the center of the cassette until it is loaded automatically.

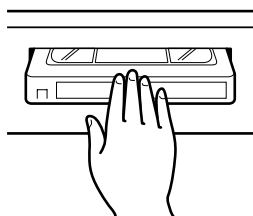

- When the cassette is loaded, the cassette indicator “●●” will light on the digital display.
- The time display will switch to the reset counter “0:00:00” display.

### NOTE:

- If you try to record on a cassette without erasure-prevention tab, the VCR will eject the cassette.

## Unloading

- 1 In STOP mode, press the **EJECT** button.
  - The cassette is automatically ejected.

### NOTES:

- Do not insert any object in the cassette loading slot, as that may cause injury and damages to the VCR.
- If your hand gets stuck in the cassette loading slot, unplug the power cord and consult the dealer where the unit was bought. Do not forcibly pull the hand out as that may cause severe injuries.

## Setting the Action to Take When a Cassette is Loaded

In the (SET UP 2) menu, you can set the mode the VCR will go into when a cassette is loaded.

- 1 Press the **MENU** button until the (SET UP 2) menu is displayed.

<SET UP 2>	
*DISPLAY	
DATE	Y
TIME	Y
ALARM COUNT	Y
*TAPE IN MODE	STOP
*TAPE END MODE	REW
*TAPE END OUT	-3M
*SERIES REC	N
*EJECT MODE	EJECT 1
*THREAD CHECK	Y

- 2 Press the **↓** button, until the “TAPE IN MODE” setting is flashing.
- 3 Press the **▼** (or **▲**) button, to set the desired mode.  
STOP . . . . . Stays in stop mode  
REC . . . . . Goes into recording mode
- 4 Press the **PAUSE/SEARCH** button to save the setting.

# NORMAL RECORDING

## Normal Recording

- 1 Turn the power on to all devices used.
- 2 Load a cassette tape with erasure-prevention tab.

### NOTE:

- If in the (SET UP 2) menu, TAPE IN MODE is set to "REC", recording will start.

- 3 Set the **ON SCREEN** switch to the "ON" position.

- 4 Press the **REC** button.

- *The Record indicator (●) lights.*
- *Recording starts.*

- 5 To stop recording, press the **STOP** button.

### NOTES:

- A tape recorded on this VCR cannot be played back completely on other SP mode only VCRs.
- If you press on the **REC** button and the loaded cassette has no erasure-prevention tab, the VCR will eject the cassette.
- During recording, the **MENU** button will not function (the menu cannot be displayed).

## [Recording Speed]

Recording speed	Maximum recording duration (with an T-160 cassette tape)		Recording interval	Audio recording	Tape motion
8	Standard mode	8 hours	1/60 second	Possible	Continuous

### TAPE COUNTER NOTES:

- There is no tape counter indication for the blank portions of the tape.
- The tape counter indicates real hours, minutes and seconds.
- There may be a slight discrepancy between the position shown on the tape counter and the actual tape position.
- When rewinding the tape past the "0:00:00" position, a minus (-) sign will be displayed.

## Record Pause

Recording can be interrupted temporarily.

- 1 Press the **PAUSE/SEARCH** button during recording.
  - *The Pause/Still indicator (II) blinks.*

### NOTES:

- The image appears on-screen but it is not recorded.
  - If a recording pause continues for 5 minutes or more, the VCR will go into stop mode to avoid damaging the tape.
- 2 To resume recording, press the **REC** button, or press the **PAUSE/SEARCH** button again.

# NORMAL RECORDING

## Setting the Mode at the End of the Tape

In the (SET UP 2) menu, you can set the mode of the VCR mode when the tape reaches the end during recording.

- 1 Press the **MENU** button until the (SET UP 2) menu is displayed.

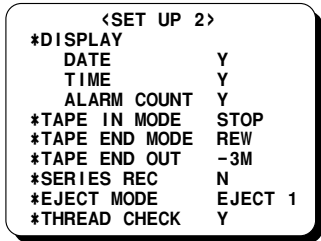

- 2 Press the **↓** button, until the “TAPE END MODE” setting is flashing.
- 3 Press the **▼** (or **▲**) button, to set the desired mode.
  - REW ..... Rewinds the tape to the beginning, then goes to stop mode
  - STOP ..... Goes to stop mode
- 4 Press the **PAUSE/SEARCH** button to save the setting.

## TAPE END Indicator Setting

- 1 Press the **MENU** button until the (SET UP 2) menu is displayed.

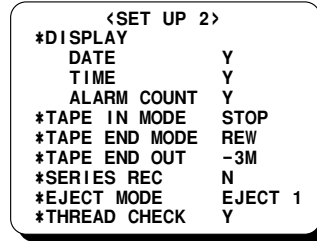

- 2 Press the **↓** button, until the “TAPE END OUT” setting is flashing.
- 3 Press the **▼** (or **▲**) button, to select the desired output mode.
  - 3M ..... The TAPE END indicator flashes when the tape counter reaches “7:57:00” and/or when the tape reaches the end.
  - END ..... The TAPE END indicator flashes when the tape reaches the end.
- 4 Press the **PAUSE/SEARCH** button, the normal screen is displayed.

### NOTES:

- If “TAPE END MODE” has been set to “REW”, the TAPE END indicator will flash while the tape is rewinding.
- Press the **EJECT**, **FF**, **REW** or **PLAY** button to turn the indicator off.

# SERIES RECORDING

Using 2 VCRs or more, the series recording function lets you switch recording from one unit to the next (only with VCRs of the same model as this one).

## Series Recording Setup

- ❶ Connect 2 VCRs or more as illustrated below.
- ❷ Set the following items as indicated.

Item	VCR No.1	VCR No.2 and on
Cassette tape	Loaded	Loaded
Operation mode	Stop	Stop
“SERIES REC” (in (SET UP 2) menu)	Y (YES)	Y (YES)
Security lock	Canceled	Set

- ❸ Press the **REC** button on VCR No.1.
  - *Recording will start in series recording mode.*
- ❹ Set the security lock on VCR No.1.

The SERIES OUT signal will be present either at the point when the counter reading is 7:57:00 or when VCR No. 1 reaches the end of the tape, whichever is first. The signal will stop 70 seconds after the tape end point of VCR No. 1.

When this signal is received by VCR No. 2, it will start recording. During the period when the SERIES OUT signal is being received by VCR No. 2, if the **STOP** button of VCR number 2 is accidentally pressed, VCR No. 2 will go into the stop mode for an instant and then return to the record mode.

To prevent this from occurring, the security lock of VCR No. 2 should be set to the on condition.

When the end of the tape is reached on VCR, the tape will rewind and then stop, if TAPE END MODE is set to “REW”. (TAPE END indicator will be flashed until the **EJECT**, **FF**, **REW**, **PLAY** or **REC** button is pressed.)

### NOTES:

- If the counter reading on VCR No.1 is 7:57:00 or more, when the **REC** button is pressed (step ❸), the recording will start on VCR No.2.
- If in the (SET UP 2) menu “SERIES REC” is set to “N”, series recording will not be possible.
- T-160 must be used for proper serial out operation.
- The counter must start from the beginning of tape, or the series recording out will not function properly.

## Series recording connections

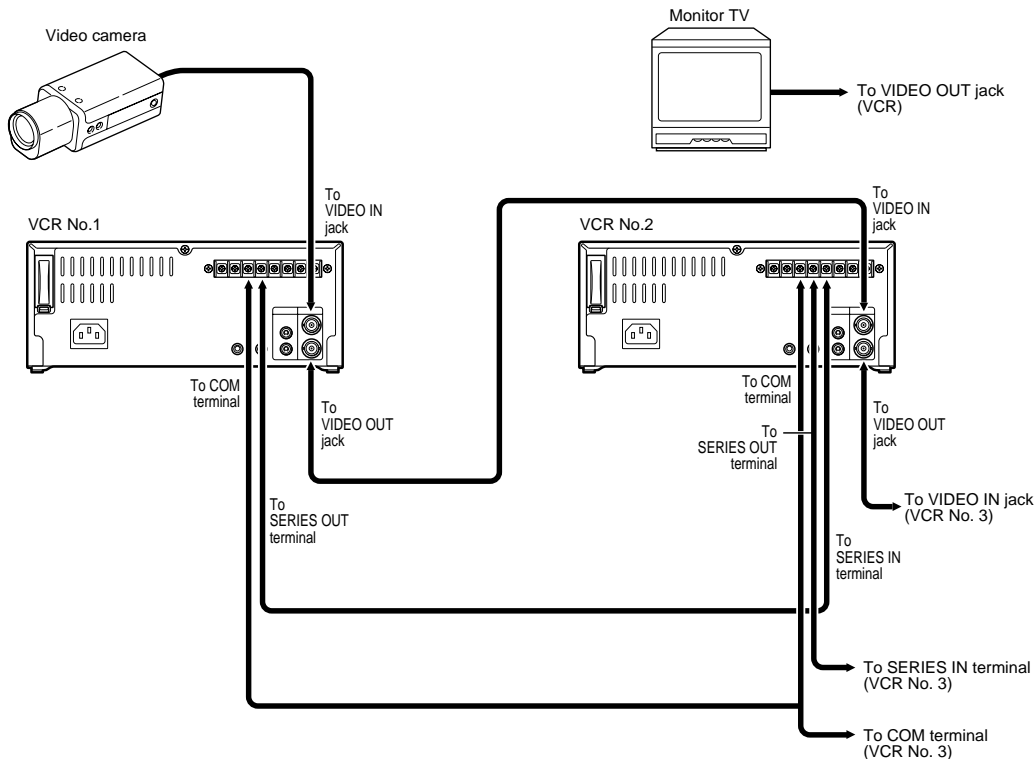

# SERIES RECORDING

## Continous Loop Recording Setup

It is possible to configure at least two this VCR for continous loop recording.

Under loop recording when the recording finishes on the first unit, the new recording will start on the second unit. When the recording finishes on the second unit, recording will start on the first unit.

- ❶ The SERIES OUT terminal of VCR No.2 and the SERIES IN terminal No.1 should be connected (See diagram).
- ❷ Set the following items as indicated.

Item	VCR No.1	VCR No.2 and on
Cassette tape	Loaded	Loaded
Operation mode	Stop	Stop
"TAPE END MODE" (in (SET UP 2) menu)	REW	REW
"SERIES REC" (in (SET UP 2) menu)	Y (YES)	Y (YES)
Security lock	Canceled	Set

- ❸ Press the **REC** button on VCR No.1.
  - *Recording will start in series recording mode.*
- ❹ Set the security lock on VCR No.1.

## NOTES:

- The "TAPE END MODE" in (SET UP 2) menu should be set to "REW" for both units without fail.
- The TAPE END indicator will continue to blink when the end of the first tape is reached.
- Under loop conditions, the tape will continue to re-record. If you need to keep the recorded infomation, please remove the tape after recording is complete and insert and new tape.

## Loop recording connection

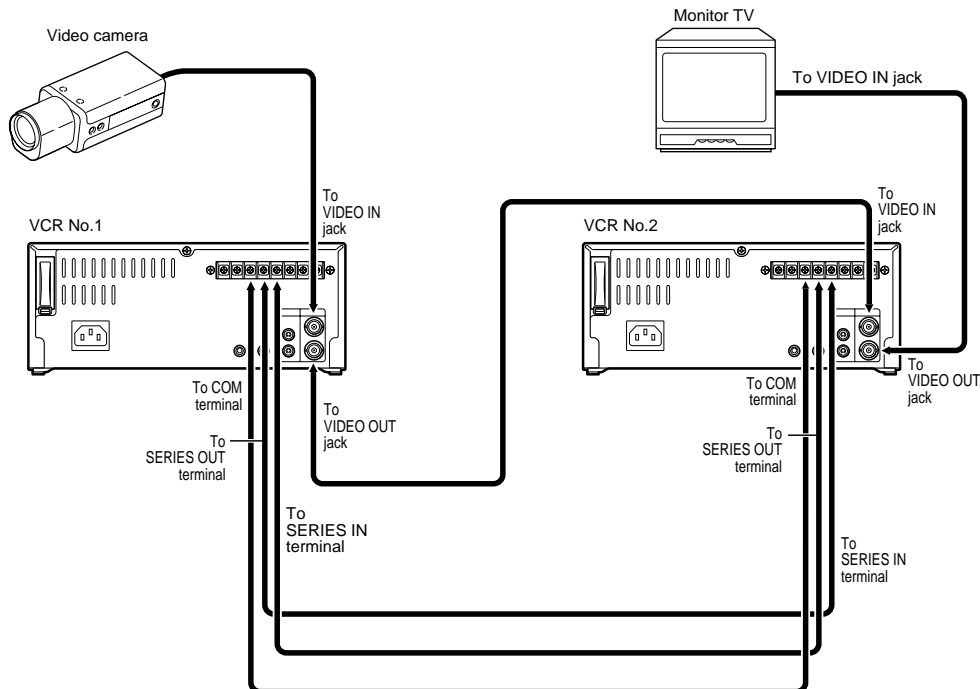

# PLAYBACK

## Normal Playback

- 1 Turn on the power to the VCR and TV monitor.
- 2 Load the video cassette tape.
- 3 Press the **PLAY** button.
  - o Playback starts.
  - o If necessary, adjust the tracking to eliminate the noise from the picture.
- 4 To stop playback, press the **STOP** button.
  - o To advance or rewind the tape, press the **FF** or **REW** button.

### NOTE:

- A tape recorded on other VCRs can be playback on this unit, however if a tape is recorded in SP mode with another VCR then its playback will be done in 2-hour (when using T-120 tape) mode.

## Tracking Control

If there is noise in the image during playback,

- 1 While looking at the playback picture, press and hold the **TRACKING/V. STILL +** button to minimize the noise.
- 2 If it cannot be minimized, press the **TRACKING/V. STILL –** button.

## Picture Search

- 1 Press the **FF** (or **REW**) button, during normal playback.
  - o The image can be seen while the tape is advanced (or rewound) at high speed.
- 2 To return to normal playback, press the **PLAY** button.

### NOTES:

- During picture search, noise (horizontal bars) will appear in the picture.
- The sound is muted.

## Still Image

- 1 Press the **PAUSE/SEARCH** button, during normal playback.
  - o A still image can be viewed.
- 2 To return to normal playback, press the **PLAY** button.

### NOTES:

- If still mode continues for 5 minutes or more, the VCR will go into stop mode to avoid damaging the tape.
- If the image is unstable (rolling vertically), adjust the vertical lock control to correct.

## Vertical Lock Control

During still image mode,

- 1 Press and hold the **TRACKING/V. STILL +** button to reduce the vertical rolling of the image.
- 2 If it cannot be corrected, press the **TRACKING/V. STILL –** button.

## Frame Advance

- 1 Press the **FF** button, during still image mode.
  - o The still image is advanced of one image (field).
- 2 To return to normal playback, press the **PLAY** button.



# DAY/TIME SEARCH

## Day/Time Search

To search for a recording when the date and time the recording was performed on are known.

- 1 Press the **PAUSE/SEARCH** button during stop mode.
  - "T/D SEARCH 01 00" will be displayed on screen.

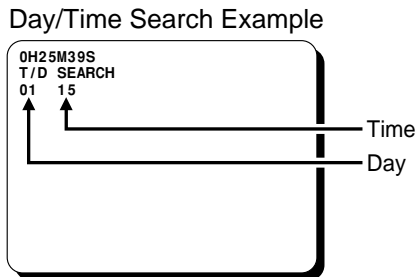

- 2 Press the ▼ (or ▲) button to set the desired day, then press the → button.
- 3 Press the ▼ (or ▲) button to set the desired hour.
- 4 Press the **FF** (or **REW**) button.
  - The desired day/time is searched and a still image of the recording will appear on-screen.
- 5 Press the **PLAY** button.
  - Playback will start.

### NOTES:

- If during a search the end of the tape is reached, the tape will rewind and stop. If the beginning of the tape is reached, it will stop.
- The day/time search function may not operate correctly if the clock on the recording VCR has been adjusted using the **CLOCK ADJUSTMENT** function.

# SETTING THE SECURITY LOCK

The security lock function is designed to prevent accidental stopping of recording if the **STOP** button is pressed inadvertently.

- 1 While holding the **TRACKING/V.STILL +** button, press the **▼** button.

- "1" is displayed on the digital display.

To cancel the security lock, while holding the **TRACKING/V.STILL +** button, press the **▼** button, "1" will be erased from the digital display.

## NOTES:

- While the security lock is engaged all commands, except the one to cancel the security lock, are disabled.
- The security lock cannot be engaged while a menu is displayed.

# CLOCK ADJUSTMENT

When using 2 or more VCRs of this same model, the clock on the second VCR and on, can be synchronized with the clock on the first VCR, using the **CLOCK ADJUSTMENT** function.

- 1 Connect the **CLOCK SET OUT** terminal on VCR 1 to the **CLOCK SET IN** terminal on VCR 2.
- 2 Repeat the procedure for all the other VCRs, connecting the **CLOCK SET OUT** terminal on VCR 2 to the **CLOCK SET IN** terminal on VCR 3, and so on.
- 3 Press the **MENU** button until the (SET UP 2) menu is displayed.
- 4 Press the **↓** button, until the "EXT TIME ADJ." (time of the adjustment) setting is flashing.
- 5 Press the **▼** (or **▲**) button to set the hour at which the adjustment will be conducted.

## NOTES:

- Be sure to set the same time on all the VCRs.
- The clock adjustment cannot be set to "00 : 00".

## Example

<SET UP 2>	
*DISPLAY	
DATE	Y
TIME	Y
*EXT TIME ADJ.	03:00
*TAPE IN MODE	STOP
*TAPE END MODE	REW
*TAPE END OUT	-3M
*SERIES REC	N
*EJECT MODE	EJECT 1

- 6 Press the **PAUSE/SEARCH** button, the normal screen is displayed.
  - *The setting procedure on the first VCR is now completed.*
- 7 Repeat the procedure for all the other VCRs, setting "EXT TIME ADJ." (to the same time as set on the first VCR).

## NOTE:

- Connect the **COM** terminal on all VCRs used.

# SETTING THE CASSETTE EJECT MODE

## Cassette Eject Setup

When using 2 VCRs or more, the cassette tape of all the VCRs or some of the VCRs can be ejected, if the **EJECT** terminals on the VCRs are connected as indicated.

- 1 Press the **MENU** button until the (SET UP 2) menu is displayed.

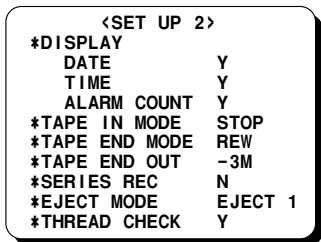

- 2 Press the **↓** button, until the “EJECT MODE” setting is flashing.
- 3 Press the **▼** (or **▲**) button to set the desired cassette eject mode.
  - EJECT1 . . . . . The cassette is ejected only if the VCR is not in recording mode.
  - EJECT2 . . . . . The cassette is ejected only if the VCR is in stop mode.
- 4 Press the **PAUSE/SEARCH** button, the normal screen is displayed.
  - *The setting procedure is now completed.*

## EJECT terminal connection

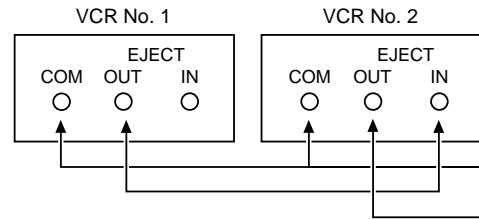

### EJECT IN terminal

- Depending on the (SET UP 2) menu “EJECT MODE” setting (see “Cassette Eject Setup”), the cassette loaded in the VCR is ejected when there is an input at this terminal.

### EJECT OUT terminal

- When the **EJECT** button is pressed or when there is an input (trigger) at the **EJECT IN** terminal, a signal is output at this terminal, even if the security lock is set or if a cassette is not loaded.

# CHECKING USAGE DURATION, POWER FAILURE AND FAILURE DUE TO CONDENSATION

- 1 Press the **MENU** button, until the (POWER FAILURE), (DEW) and (USED TIME) menu is displayed.

(POWER FAILURE) . . . The number of power failures, and the date and time of the most recent power failure and recovery are displayed.

(DEW) . . . . . The number of failures due to condensation, and the date and time of the most recent failure and recovery are displayed.

(USED TIME) . . . . . The video heads usage duration and the power on duration are displayed.

## Example

```
<POWER FAILURE>
002 FAILURE 12-10 07:15
RECOVERY12-10 07:30

<DEW>
001 FAILURE 12-10 11:00
RECOVERY12-10 12:00

<USED TIME>
VIDEO 00003H
POWER 00007H
```

- 2 Press the **PAUSE/SEARCH** button, the normal screen is displayed.

## NOTE:

- If the **MENU RESET** button is pressed while the menu is displayed, the (POWER FAILURE) and (DEW) data is erased. The (USED TIME) data cannot be reset. "P" will be erased from the digital display.

# MAINTENANCE

## Daily Inspection

The following daily inspections are recommended in order to assure long-term and trouble-free operation of the unit.

The daily inspections are particularly important.

## Inspection Procedure

- ❶ Turn on the power to the VCR, camera, TV monitor and other connected devices.
- ❷ Check that the image received on the TV monitor is correct.
- ❸ Check that the on-screen display of the date and time is correct.
- ❹ To check the recording condition of the previous day, rewind the recorded tape a few seconds.
- ❺ Press the **PLAY** button and check that the playback image is correct.
- ❻ Check that the recorded date and time are correct.

### NOTES:

- If the security lock is engaged, it has to be released before proceeding to the inspection.
- If any problem is discovered during the inspection, unplug the power cord then consult your dealer.

## Periodic Inspection

Periodic inspection and maintenance should be referred to your dealer.

If there is noise in the playback picture, and it cannot be corrected using the tracking control, it may indicate that the video heads need cleaning.

The video heads should be inspected every 1,000 hours of use to determine if they need to be replaced.

The video heads usage can be checked using the (USED TIME) menu.

## Head Care and Cleaning

The VCR has a built-in automatic head cleaner. Under normal conditions, the heads should not require additional cleaning.

## Cabinet Cleaning

Clean the outside of the cabinet with a clean, soft cloth, moistened with lukewarm water and wrung dry.

DO NOT USE SOLVENTS OR OTHER TYPES OF CLEANERS. THESE CHEMICALS CAN CRACK OR DISCOLOR THE CABINET.

# TROUBLESHOOTING GUIDE

If the unit does not operate normally when you follow the instructions indicated in the manual, please refer to the table below.

SYMPTOM	POSSIBLE CAUSE	CORRECTIVE ACTION
No power	The power cord is not connected	Connect the power cord
No image displayed on the monitor TV	The connections are not correct	Check that all connections are correct
	The power to the camera and/or monitor TV is not turned on	Turn all connected devices power on
The buttons do not respond	A cassette tape is not loaded	Load a cassette
	All functions are suspended due to condensation	Wait for the "ddd" indicator to go off
	The security lock is engaged	Cancel the security lock
Recording is not possible (the tape is ejected)	The loaded cassette has no erasure-prevention tab	Load a cassette tape with erasure-prevention tab or cover the tab hole with adhesive tape
Noise in the playback picture	The video heads need cleaning	Clean the video heads
The date and time are not recorded	The ON SCREEN switch is set to the "OFF" position	Set the <b>ON SCREEN</b> switch to the "ON" position
The cassette tape cannot be ejected	Problem with the system	Unplug the power cord then plug it back in

## System Down

If the unit does not function at all, try the following.

- ❶ Unplug the power cord then plug it back in.
- ❷ Reset the memory. (Press the **ALL RESET** button. Under normal conditions, do not touch the **ALL RESET** button.)
- ❸ If the problem is not corrected after performing steps ❶ and ❷ a few times, consult your dealer.

# SPECIFICATIONS

## General Specifications

Video heads system	Dual-azimuth 4-head rotating helical scanning system: Dual azimuth 2-head for record and standard playback Dual azimuth 4-head for cue, review and still mode
Audio recording	In 8-hour modes
Tape speed	11.12 mm /sec
Specified video cassette tape	VHS 1/2 inch video cassette tape
Recording/playback time	8 hours (when using T-160 tape)
Fast forward/rewind time	approximately 3 minutes 30 seconds (when using T-160 tape)
Television system	NTSC color TV system

## Video

Recording method	Luminance signal: FM recording Chrominance signal: Down-converted direct recording
Video input	1 Vp-p, BNC, 75 $\Omega$ , unbalanced
Video output	1 Vp-p, BNC, 75 $\Omega$ , unbalanced
Horizontal resolution	Black & white mode            350 line or more Color mode                        300 line or more

## Audio

Input	-8 dBs, RCA pin jack, 27 k $\Omega$ , unbalanced
Output	-8 dBs, RCA pin jack, 600 $\Omega$ , unbalanced
Microphone input	-60 dBs, 3.5 mm mini jack, 10 k $\Omega$ , unbalanced

## Connectors

Clock set input	Contact closes with no voltage
Clock set output	DC 5 V ( $\pm 0.5$ )/5.7 k $\Omega$
Series input	Contact closes with no voltage
Series output	DC 5 V ( $\pm 0.5$ )/5.7 k $\Omega$
Eject input	Contact closes with no voltage
Eject output	DC 5 V ( $\pm 0.5$ )/5.7 k $\Omega$
Common	0 V (GND)
Remote control input	3.5 mm mini jack

## Other Specifications

Operating temperature range	5°C to 40°C
Operating humidity range	80% or less
Power requirements	AC 120 V, 60 Hz
Power consumption	17 W
Dimensions	240 (W) x 96.5 (H) x 335 (D) mm
Weight	approximately 3.8 kg

**NOTE:** The specifications and external appearance of this unit are subject to change without notice.

# SANYO INDUSTRIAL VIDEO VCR LIMITED WARRANTY

## OBLIGATIONS

In order to obtain warranty service, the product must be delivered to and picked up from an Authorized Sanyo Service Center at the user's expense, unless specifically stated otherwise in this warranty. The names and addresses of Authorized Sanyo Service Centers may be obtained by writing to SFS Corporation, SFC's warranty administrator, at any of the addresses listed below, or by calling (toll-free) 1-800-421-5013.

New Jersey Office  
210 Riser Road Little Ferry, NJ 07643  
201-641-3000

California Office  
1200 W. Artesia Blvd. Compton, CA 90220  
310-537-5830

Illinois Office  
900 N. Arlington Heights Rd. Itasca, IL 60143  
708-775-1414

THIS WARRANTY IS VALID ONLY ON SANYO PRODUCTS PURCHASED OR RENTED IN THE UNITED STATES OF AMERICA, EXCLUDING HAWAII AND ALL U.S. TERRITORIES AND PROTECTORATES. THIS WARRANTY APPLIES ONLY TO THE ORIGINAL RETAIL USER. THE ORIGINAL DATED BILL OF SALE, SALES SLIP OR RENTAL AGREEMENT MUST BE SUBMITTED TO THE AUTHORIZED SANYO SERVICE CENTER AT THE TIME WARRANTY SERVICE IS REQUESTED.

Subject to the OBLIGATIONS above and EXCLUSIONS below, SANYO FISHER COMPANY warrants this SANYO product against defects in materials and workmanship for the periods specified below. SFC will repair or replace (at its option) the product and any of its parts which fail to conform to this warranty. The warranty period commences on the date the product was first purchased or rented at retail.

LABOR	PARTS	VIDEO HEADS
90 DAYS	1 YEAR	90 DAYS

## EXCLUSIONS

This warranty does not cover (A) the adjustment of customer-operated controls as explained in the appropriate model's instruction manual, or (B) the repair of any product whose serial number has been altered, defaced or removed.

This warranty shall not apply to the cabinet or cosmetic parts, broken or damaged video heads, knobs or routine maintenance.

This warranty does not apply to uncrating, setup, installation, removal of the product for repair or reinstallation of the product after repair.

This warranty does not apply to repairs or replacements necessitated by any cause beyond the control of SFC including, but not limited to, any malfunction, defect or failure caused by or resulting from unauthorized service or parts, improper maintenance, operation contrary to furnished instructions, shipping or transit accidents, modification or repair by the user, abuse, misuse, neglect, accident, incorrect power line voltage, fire, flood or other Acts of God, or normal wear and tear.

The foregoing is in lieu of all other expressed warranties and SFC does not assume or authorize any party to assume for it any other obligation or liability.

THE DURATION OF ANY WARRANTIES WHICH MAY BE IMPLIED BY LAW (INCLUDING THE WARRANTIES OF MERCHANTABILITY AND FITNESS) IS LIMITED TO THE TERM OF THIS WARRANTY. IN NO EVENT SHALL SFC BE LIABLE FOR SPECIAL, INCIDENTAL OR CONSEQUENTIAL DAMAGES ARISING FROM OWNERSHIP OR USE OF THIS PRODUCT, OR FOR ANY DELAY IN THE PERFORMANCE OF ITS OBLIGATIONS UNDER THIS WARRANTY DUE TO CAUSES BEYOND ITS CONTROL. SOME STATES DO NOT ALLOW LIMITATIONS ON HOW LONG AN IMPLIED WARRANTY LASTS AND/OR DO NOT ALLOW THE EXCLUSION OR LIMITATION OF CONSEQUENTIAL DAMAGES, SO THE ABOVE LIMITATIONS AND EXCLUSIONS MAY NOT APPLY TO YOU.

THIS WARRANTY GIVES YOU SPECIFIC LEGAL RIGHTS. YOU MAY HAVE OTHER RIGHTS, WHICH VARY FROM STATE TO STATE.

## ATTENTION

For your protection in the event of theft or loss of this product, please fill in the information below for you own personal records.

**Model No.** \_\_\_\_\_

**Serial No.** \_\_\_\_\_  
(Located on back or bottom side of unit.)

**Date of Purchase** \_\_\_\_\_

**Purchase Price** \_\_\_\_\_

**Where Purchased** \_\_\_\_\_



21605 Plummer Street,  
Chatsworth, California 91311

1AC6P1P1742A-C  
NU4Q/U  
(0999KP-SY01)

Issue No. 4

Copyright SANYO, 1998 All rights reserved.

Printed in Indonesia